

## MM58348 High Voltage Display Driver

### General Description

The MM58348 is a monolithic MOS integrated circuit utilizing CMOS metal gate low threshold P and N-channel devices. It is available both in 40-pin molded dual-in-line packages or as dice. The MM58348 is particularly suited for driving high voltage (35V max) vacuum fluorescent (VF) displays (e.g., a 5 x 7 dot matrix display).

### Features

- Direct interface to high voltage display
- Serial data input
- No external resistors required
- Wide display power supply operation
- LSTTL compatible inputs
- Software compatible with NS display driver family
- Compatible with alphanumeric or dot matrix displays
- No load signal required

### Applications

- COPST<sup>™</sup> or microprocessor-driven displays
- Instrumentation readouts
- Industrial control indicator
- Digital clock, thermostat, counter, voltmeter
- Word processor text displays
- Automotive dashboards

### Block Diagram

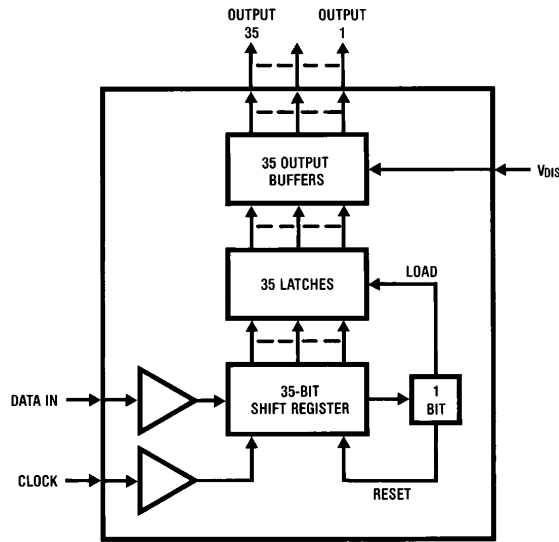

FIGURE 1

TL/F/5601-1

## Absolute Maximum Ratings

If Military/Aerospace specified devices are required, please contact the National Semiconductor Sales Office/Distributors for availability and specifications.

Voltage at Any Input Pin	$V_{DD} + 0.3V$ to $V_{SS} - 0.3V$
Voltage at Any Display Pin	$V_{DD}$ to $V_{DD} - 36.5V$
$V_{DD} +  V_{DIS} $	36.5V
Storage Temperature	-65°C to + 150°C
Power Dissipation at 25°C	
Molded DIP Package, Board Mount	2.28W*
Molded DIP Package, Socket Mount	2.05W**
*Molded DIP Package, Board Mount, Derate 21.7 mW/°C Above 25°C	$\theta_{JA} = 46^\circ\text{C/W}$
**Molded DIP Package, Socket Mount, Derate 19.6 mW/°C Above 25°C	$\theta_{JA} = 51^\circ\text{C/W}$
Junction Temperature	130°C
Lead Temperature (Soldering, 10 seconds)	260°C

## Operating Conditions

	Min	Max	Units
Supply Voltage ( $V_{DD}$ )			
$V_{SS} = 0V$	4.5	5.5	V
Display Voltage ( $V_{DIS}$ )	-30	-10	V
Temperature Range	-40	+85	°C

## DC Electrical Characteristics

$T_A = -40^\circ\text{C}$  to  $+85^\circ\text{C}$ ,  $V_{DD} = 5V \pm 0.5V$ ,  $V_{SS} = 0V$  unless otherwise specified.

Symbol	Parameter	Conditions	Min	Typ	Max	Units
$I_{DD}$	Power Supply Currents	$V_{IN} = V_{SS}$ or $V_{DD}$ , $V_{DD} = 5.5V$ , $V_{SS} = 0V$ , $V_{DIS}$ Disconnected			150	$\mu\text{A}$
$I_{DIS}$					10	mA
$V_{IL}$	Input Logic Levels DATA IN, CLOCK Logic '0'				0.8	V
$V_{IH}$			Logic '1'	2.4		V
$I_{IN}$	Input Currents DATA IN, CLOCK	$V_{IN} = 0V$ or $V_{DD}$	-10		10	$\mu\text{A}$
$C_{IN}$	Input Capacitance DATA IN, CLOCK				15	pF
$R_{OFF}$	Display Output Impedances Output Off (Figure 3a)	$V_{DD} = 5.5V$ , $V_{SS} = 0V$ $V_{DIS} = -10V$ $V_{DIS} = -20V$ $V_{DIS} = -30V$	55		250	k $\Omega$
			60		300	k $\Omega$
			65		400	k $\Omega$
$R_{ON}$			Output On (Figure 3b)	$V_{DIS} = -10V$ $V_{DIS} = -20V$ $V_{DIS} = -30V$		700
				600	750	$\Omega$
				500	680	$\Omega$
$V_{DOL}$	Display Output Low Voltage	$V_{DD} = 5.5V$ , $I_{OUT} = \text{Open Circuit}$ , $-30V \leq V_{DIS} \leq -10V$	$V_{DIS}$		$V_{DIS} + 2$	V

Note 1: 74LSTTL  $V_{OH} = 2.7V$  @  $I_{OUT} = -400 \mu\text{A}$ , TTL  $V_{OH} = 2.4V$  @  $I_{OUT} = -400 \mu\text{A}$ .

## AC Electrical Characteristic $T_A = -40^\circ\text{C}$ to $+85^\circ\text{C}$ , $V_{DD} = 5V \pm 0.5V$

Symbol	Parameter	Conditions	Min	Typ	Max	Units
$f_C$	Clock Input Frequency	(Notes 2 and 3)			1.0	MHz
$t_H$	Clock Input High Time		300			ns
$t_L$	Clock Input Low Time		300			ns
$t_{DS}$	Data Input Set-Up Time		100			ns
$t_{DH}$	Data Input Hold Time		100			ns

Note 2: AC input waveform specification for test purpose:  $t_r \leq 20 \text{ ns}$ ,  $t_f \leq 20 \text{ ns}$ ,  $f = 1 \text{ MHz}$ , 50%  $\pm 10\%$  duty cycle.

Note 3: Clock input rise and fall times must not exceed 5  $\mu\text{s}$ .

# Connection Diagrams

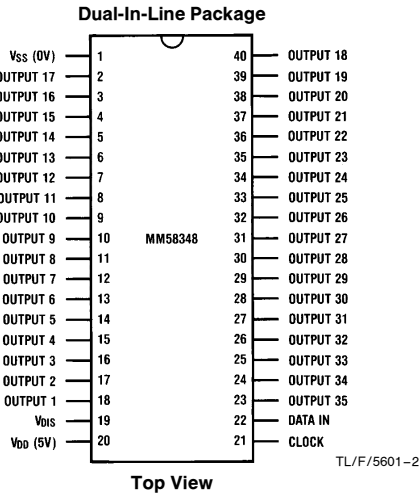

Top View

FIGURE 2

Order Number MM58348N  
See NS Package Number N40A

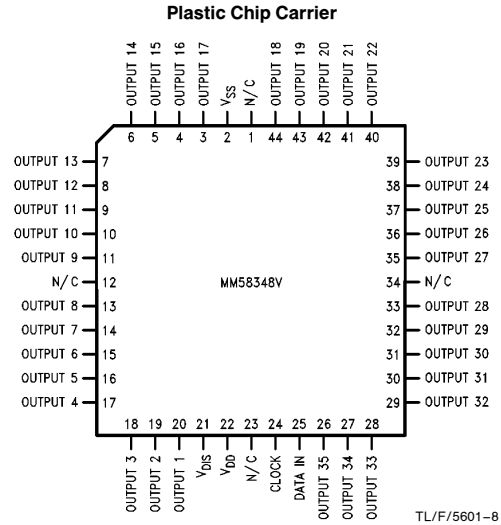

Top View

Order Number MM58348V  
See NS Package Number V44A

## Functional Description

This product is specifically designed to drive multiplexed or non-multiplexed high voltage alphanumeric or dot matrix vacuum fluorescent (VF) displays. Character generation is done externally in the microprocessor, with a serial data path to the display driver. The MM58348 uses two signals, DATA IN and CLOCK, with a format of a leading "1" followed by the 35 data bits, hence allowing data transfer without an additional signal. A block diagram of the MM58348 is shown in Figure 1.

Figure 2 shows the pinout of the MM58348 device, where output 1 (pin 18) is equivalent to bit 1, (i.e., the first bit of

data to be loaded into the shift register following the start bit). A logic "1" at the input will turn on the corresponding display digit/segment/dot output.

A significant reduction in discrete board components can be achieved by use of the MM58348, because external pull-down resistors are not required. Due to the nature of the output stage, both its on and off impedance values vary as a function of the display voltage applied. However, Figure 3a and 3b show that this output impedance will remain constant for a fixed value of display voltage.

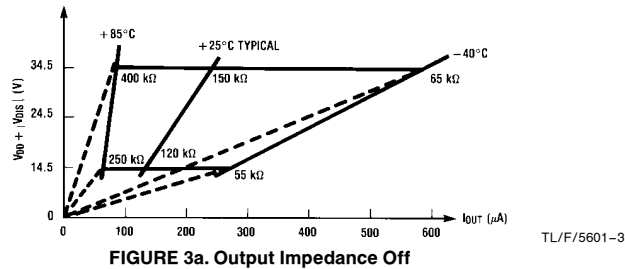

FIGURE 3a. Output Impedance Off

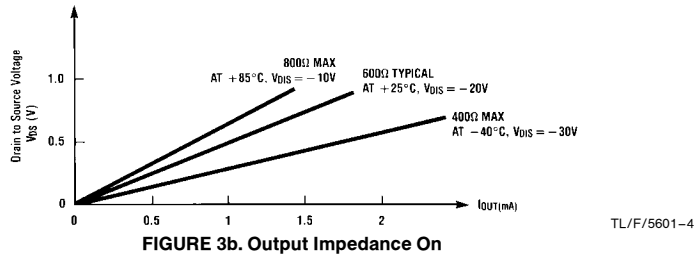

FIGURE 3b. Output Impedance On

## Functional Description (Continued)

Figure 4 demonstrates the critical timing requirements between CLOCK and DATA IN for the MM58348.

In Figure 5, a start bit of logic "1" precedes the 35 bits of data, each bit being accepted on the rising edge of CLOCK, i.e., a "0"–"1" transition. At the 36th clock, a LOAD signal is generated synchronously with the high state of the clock, thus loading the 35 bits of the shift register into the latches. At the low state of the clock, a RESET signal is generated, clearing all bits of the shift register for the next set of data. Hence, a complete set of 36 clock pulses is needed to clear (reset) the display driver at "power on" or any time, the following flushing routine may be used. Clock in 36 "ze-

rees", followed by a "one" (start bit), followed by 35 "zeroes". This procedure will completely blank the display. It is recommended to clear the driver at power on.

Figure 6 shows a schematic diagram of a microprocessor-based system where the MM58348 is used to provide the anode drive for a 32-digit 5 x 7 dot matrix vacuum fluorescent (VF) display. The grid drive in this example is provided by another member of the high voltage display driver family, namely the MM58341, which has the additional features of a BLANKING CONTROL pin, a DATA OUT pin, and an ENABLE (external load signal) pin.

## Timing Diagrams

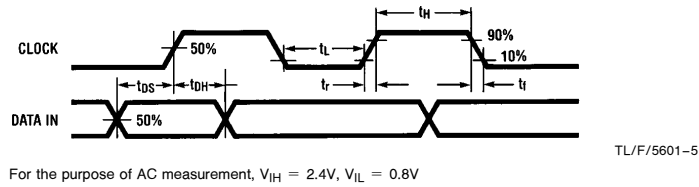

FIGURE 4. Clock and Data Timings

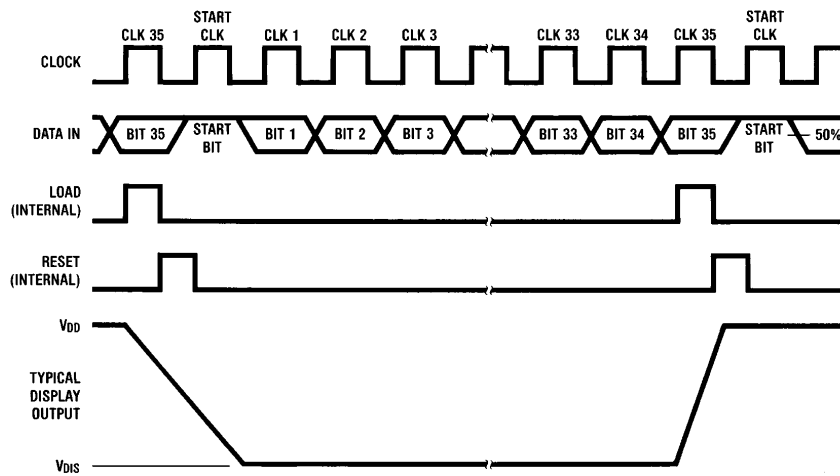
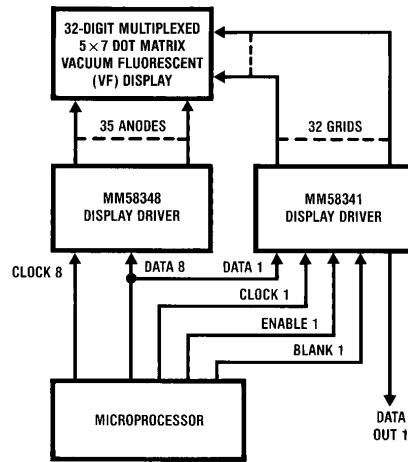

FIGURE 5. MM58348 Timings (Data Format)

## Typical Application



TL/F/5601-7

FIGURE 6. Microprocessor-Controlled Word Processor

## Physical Dimensions inches (millimeters)

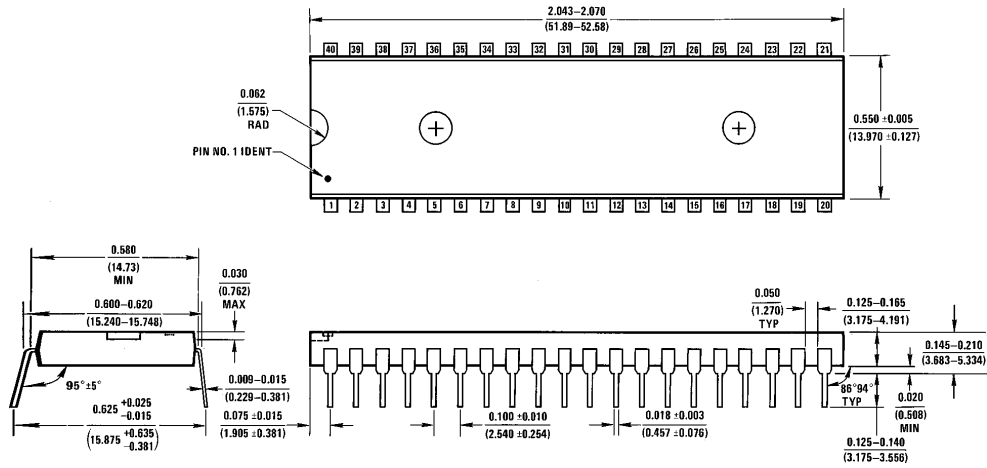

MSA (REV E)

**Molded Dual-In-Line Package (N)**  
**Order Number MM58348N**  
**NS Package Number N40A**

**Physical Dimensions** inches (millimeters) (Continued)

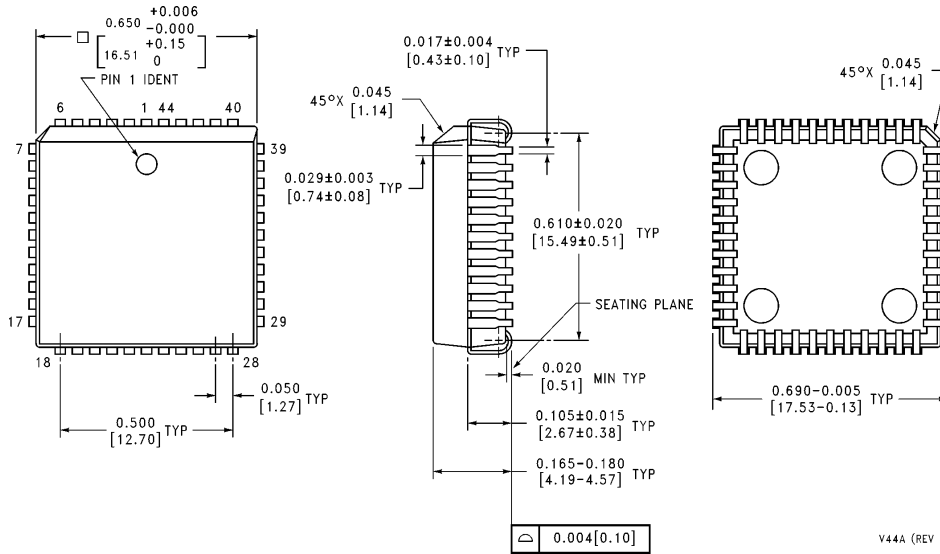

**Plastic Chip Carrier (V)**  
**Order Number MM58348V**  
**NS Package Number V44A**

V44A (REV K)

**LIFE SUPPORT POLICY**

NATIONAL'S PRODUCTS ARE NOT AUTHORIZED FOR USE AS CRITICAL COMPONENTS IN LIFE SUPPORT DEVICES OR SYSTEMS WITHOUT THE EXPRESS WRITTEN APPROVAL OF THE PRESIDENT OF NATIONAL SEMICONDUCTOR CORPORATION. As used herein:

1. Life support devices or systems are devices or systems which, (a) are intended for surgical implant into the body, or (b) support or sustain life, and whose failure to perform, when properly used in accordance with instructions for use provided in the labeling, can be reasonably expected to result in a significant injury to the user.
2. A critical component is any component of a life support device or system whose failure to perform can be reasonably expected to cause the failure of the life support device or system, or to affect its safety or effectiveness.



**National Semiconductor Corporation**  
 1111 West Bardin Road  
 Arlington, TX 76017  
 Tel: 1(800) 272-9959  
 Fax: 1(800) 737-7018

**National Semiconductor Europe**  
 Fax: (+49) 0-180-530 85 86  
 Email: cnjwge@tevm2.nsc.com  
 Deutsch Tel: (+49) 0-180-530 85 85  
 English Tel: (+49) 0-180-532 78 32  
 Français Tel: (+49) 0-180-532 93 58  
 Italiano Tel: (+49) 0-180-534 16 80

**National Semiconductor Hong Kong Ltd.**  
 19th Floor, Straight Block,  
 Ocean Centre, 5 Canton Rd.  
 Tsimshatsui, Kowloon  
 Hong Kong  
 Tel: (852) 2737-1600  
 Fax: (852) 2736-9960

**National Semiconductor Japan Ltd.**  
 Tel: 81-043-299-2309  
 Fax: 81-043-299-2408

National does not assume any responsibility for use of any circuitry described, no circuit patent licenses are implied and National reserves the right at any time without notice to change said circuitry and specifications.

This datasheet has been download from:

[www.datasheetcatalog.com](http://www.datasheetcatalog.com)

Datasheets for electronics components.